

20 AG series

x20x06mm

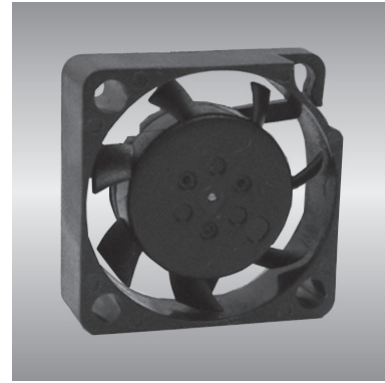

General Specifications

- Motor : 4 Poles brushless DC motor
- Frame & Impeller : Plastic(UL 94V-0)
- Storage temperature : -40° to +75°
- Operating temperature : -10° to +70°

Major Characteristic Parameters

Model	*Bearing System	Rated Voltage	Operating Voltage Range	Rated Current	Rated Speed	Maximum Air Flow		Maximum Static Pressure		Sound Level	Weight
Part NO.	B / S / F	V	V	A	RPM	m ³ /min	CFM	mm-H ₂ O	In-H ₂ O	dBA	g
AGE02006_05L	F	5	4.5~5.5	0.07	7000	0.01	0.35	1.1	0.04	22.3	4
AGE02006_12L	F	12	7.0~13.2	0.06	7000	0.01	0.35	1.1	0.04	22.3	4
AGE02006_05M	F	5	4.5~5.5	0.09	10000	0.02	0.71	1.9	0.07	29.0	4
AGE02006_12M	F	12	7.0~13.2	0.08	10000	0.02	0.71	1.9	0.07	29.0	4
AGE02006_05H	F	5	4.5~5.5	0.11	13000	0.03	1.06	3.2	0.12	32.0	4
AGE02006_12H	F	12	7.0~13.2	0.09	13000	0.03	1.06	3.2	0.12	32.0	4

*Bearing system B: Two Ball Bearing F: Fluid Bearing S: Sleeve Bearing

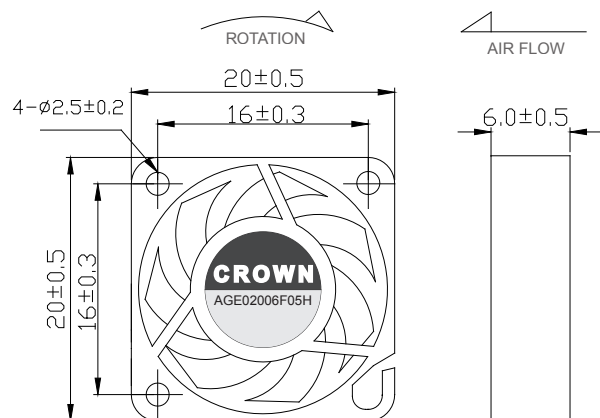
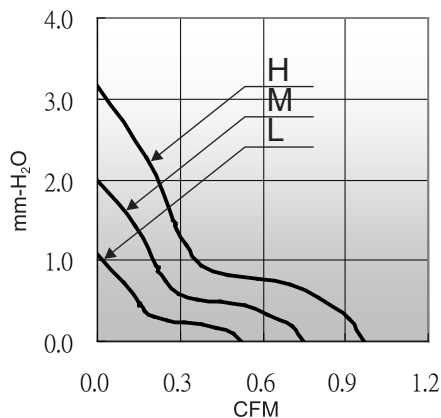

unit:mm